

ALC

Aluminium Lighting Company

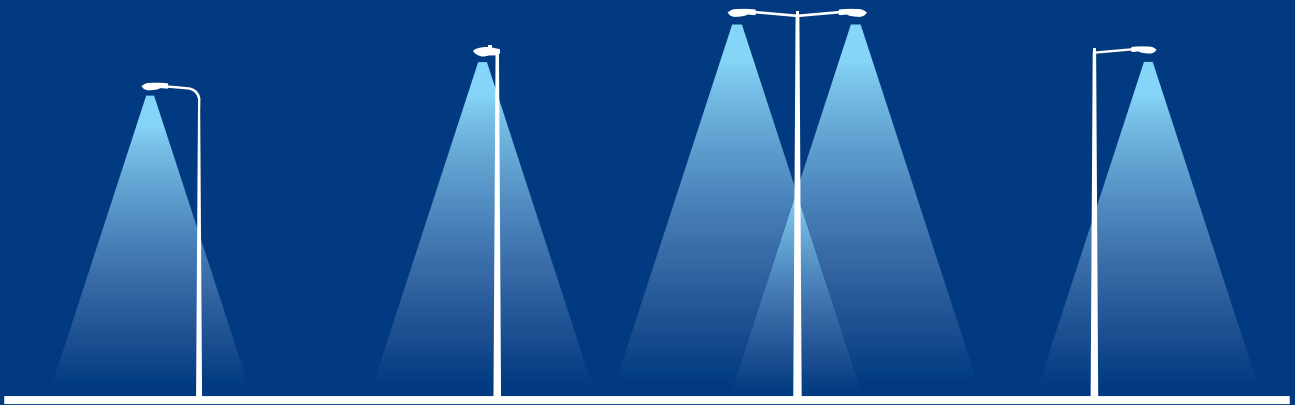

lighting columns

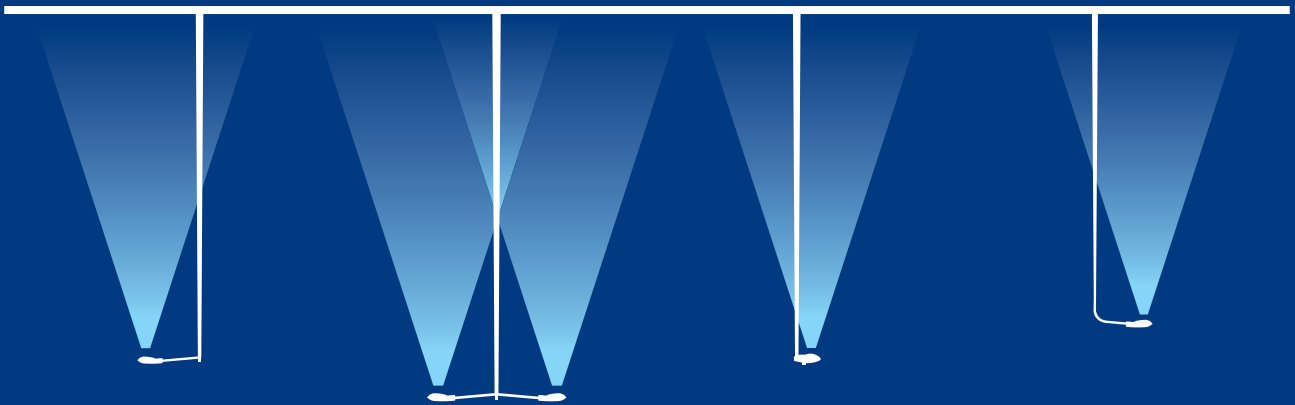

in partnership with

Nedal
ALUMINIUM

www.aluminium-lighting.com

passively safe

robust

low maintenance

long life

sustainable

For a lighter, brighter future



At the Aluminium Lighting Company (ALC), we believe our success comes from dedication to our core values. We pride ourselves on our teamwork-focused customer service, our operational excellence and the innovative nature of our products and services.

As the first company to introduce extruded aluminium lighting columns into the UK and the leading supplier of these products in the country, we are uniquely positioned to advise lighting engineers, architects, local authorities and developers.

Our intelligently engineered aluminium outperforms other column types in terms of passive safety and ongoing maintenance costs, and doesn't even require painting. We provide a wide standard range along with more aesthetic bespoke options and offer whole-life cost savings and wide-ranging regulatory compliance.

Benefits across the board

All the benefits of aluminium and our manufacturing expertise apply equally to our range of market-leading lighting columns, traffic signal poles, signposts and bespoke products:

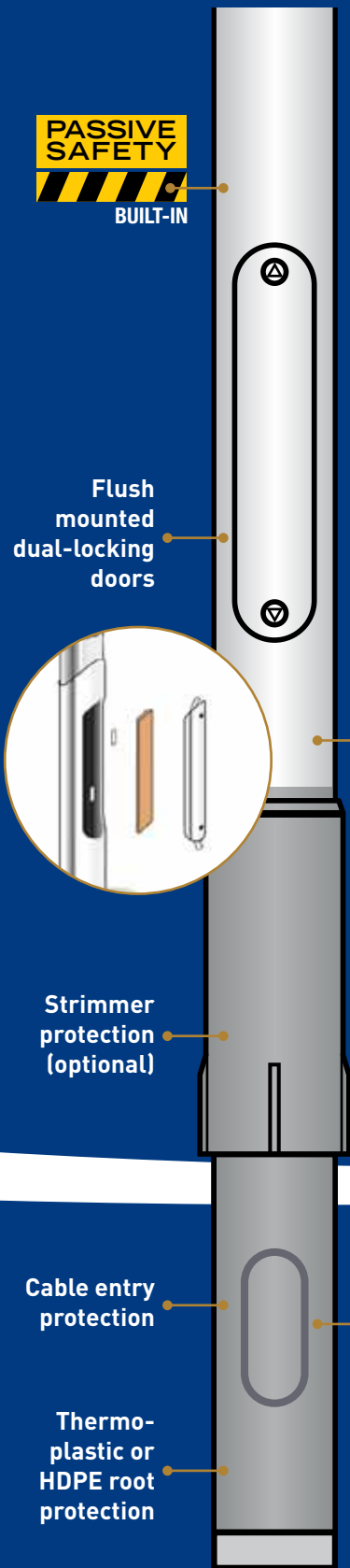

Strength



Any potential structural weakness near the door is negated by our unique use of type 5 press-stressed aluminium reinforcing tube inserts – a weld-free process that dramatically increases strength.



Quality of manufacture

With decades of experience and partnership with Nedal, one of Europe's leading suppliers of extruded aluminium products, ALC offers unbeatable quality that fits UK market needs.

Bonding/welding



Our press-stressed inner sleeve reinforcement technology is weld-free and guarantees column strength. We use structural bonding for fixings/brackets and any welding that is undertaken is done to the highest technical standard by coded welders. We undertake rigorous weld calculations.

“Elegant, robust and passively safe: no wonder conical columns are our most popular product.”

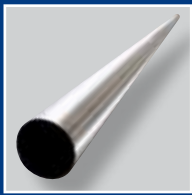

Easy installation

Aluminium is far lighter than competing materials, making installation simpler, quicker and more cost effective. We apply cable entry guards to prevent chaffing on openings, and offer a column base protector.



Post top



Hockey stick



Single bracket



Dual bracket



**BRITISH
KNOW HOW**



50 year design life

Our columns far outlast those of our rivals (with a track record of over 65 years in the ground), and require no structural integrity surveying throughout their long design life.



Extra features

An integrated DIN rail makes for easy adjustment of the wooden backboard, and our flush column doors are dual-locked with anti-tamper bolts. Strimmer protection and other features are available.

Clearly better from any angle

Columns for any scheme

Choice is the key. We offer our customers a quality column range which can be selected easily, and delivered quickly from our large stocks. That same quality column range can fit seamlessly into an existing scheme, or make a bold forward-looking statement in a new development or lighting scheme.

We can also create more bespoke columns for our customers, taking their concepts or designs and creating something truly unique, in aluminium.

No matter what your requirement, we offer quick, friendly service and a return on investment which is unbeatable. We also offer the most environmentally-effective products on the market, so you can develop a lighting scheme that won't cost the earth.

ALC lighting columns are available with the following options

- Anodised, painted or powder coated
- With base plate
- With completely insulated synthetic base holder (HDPE), only available for columns with a base diameter of 165mm or less
- The expanded reinforcement tube can be extended from the service door to 200mm below the ground, so that the wall thickness is doubled to ground level
- With strimmer protection



“No matter what your project, ALC has the column to match.”





Conical	Hockey	Stepped	Stepped hockey	Cylindrical
Light source height (m)	Light source height (m)	Light source height (m)	Light source height (m)	Light source height (m)
3-18	3-15	3-18	3-15	3-15
Base diameter (mm)	Base diameter (mm)	Base diameter (mm)	Base diameter (mm)	Base diameter (mm)
114, 120, 135, 145, 165, 177, 190, 202, 222	114, 120, 135, 145, 165, 177, 190, 202, 222	114, 120, 135, 145, 165, 177, 190, 202, 222	114, 120, 135, 145, 165, 177, 190, 202, 222	114, 120, 135, 145, 165, 177, 190, 202, 222
Top diameter (mm)	Top diameter (mm)	Top diameter (mm)	Top diameter (mm)	Top diameter (mm)
60, 76, 90	60, 76, 90	60, 76, 90	60, 76, 90	114, 120, 135, 145, 165, 177, 190, 202, 222
Optional bracket length (mm)	Bracket lengths (mm)	Optional bracket length (mm)	Bracket lengths (mm)	Optional bracket length (mm)
up to 2000	300 – 2000	up to 2000	300 – 2000	up to 2000
	Uplift (°)		Uplift (°)	
	5, 10, 15		5, 10, 15	

* Lighting columns are provided as a standard feature with thermoplastic root protection and an expanded inner reinforcement tube with an integrated mounting rail, which comes with 2 sliding nuts and an earthed bolt.

Conical columns



The future of street lighting

High load capacity and extremely high rigidity – our conical column is a design you can rely on. By creating the column from a single piece of extruded aluminium (plus an additional type 5 press-stressed aluminium inner-sleeve around the door, fixed in such a way as to be considered part of the column extrusion in terms of structural behaviour), we offer a product that is stable and strong by design.

The modern, clean lines represent the future of our nation's roadsides, and in its native aluminium finish it has a natural shine and quality that competing materials cannot hope to match.

The exact specifications are up to you: you can select from a variety of column heights, mounting types, lantern fixings and brackets.

All of our columns are supplied with cable entry guards to minimise cable chaffing during installation, and they're so light they can be easily installed on site, often without the need for any lifting equipment. Brackets are structurally bonded and connected to the column via a braided stainless steel lanyard for extra security in case of a vehicle collision with the column, which is itself passively safe on account of aluminium's inherent energy-absorbing qualities.

Our columns are manufactured in accordance with BS EN 40:2003.

Check out our interactive column selector at www.aluminium-lighting.com



“Elegant, robust and passively safe: no wonder conical columns are our most popular product.”



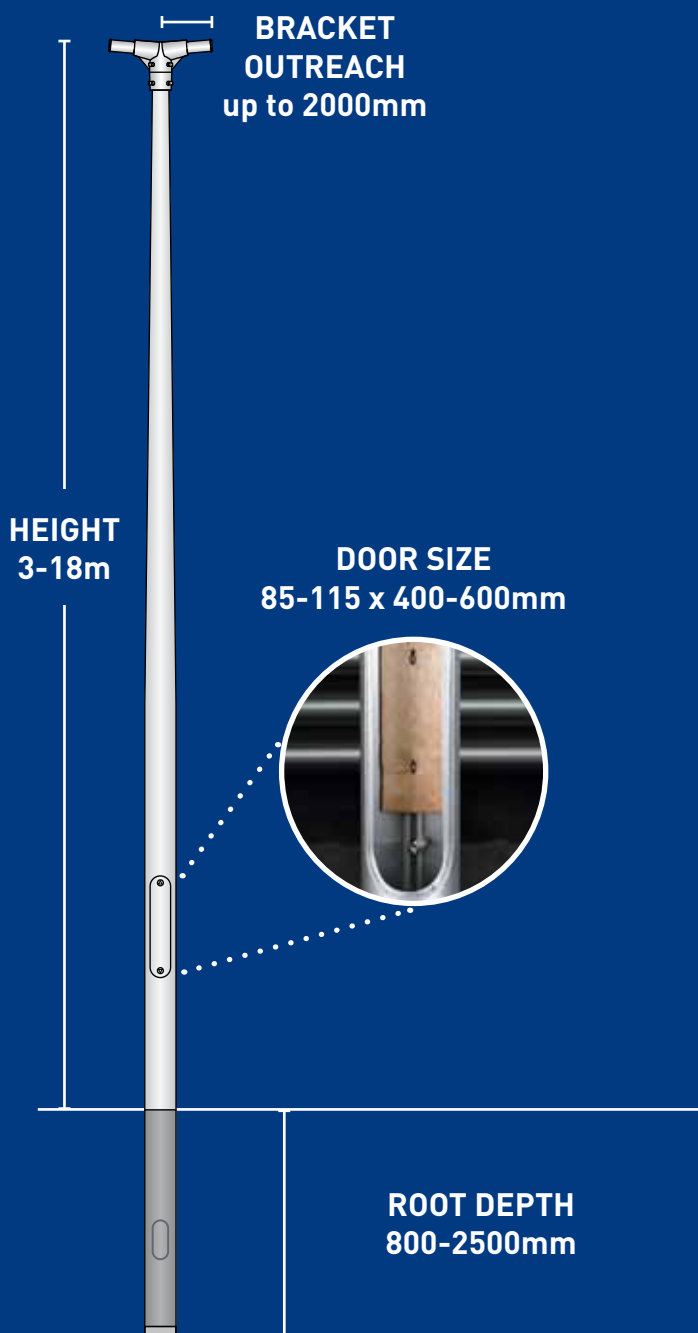

Height above ground (m)	Base diameter (mm)	Root depth (mm)	Door size (mm)	Ground to top of cable entry (mm)	Cable entry size (mm)	Diameter at post top (mm)
4	135-145	800	100 x 600	325	175 x 75	76/90
5	135-155	800	85-100 x 400-600	325	175 x 75	76/90
6	135-165	1000	100-115 x 500-600	325	175 x 75	76/90
8	165-202	1200	100-115 x 600	325	175 x 75	76/90
10	177-202	1500	100-115 x 600	325	175 x 75	76/90
12	177-222	1700	100 x 600	325	175 x 75	76/90
15	177-222	2000	100-115 x 600	325	175 x 75	76/90
18	222	2500	100 x 600	325	175 x 75	76

Mounting

Flange plate mounting is available as an alternative to a conventional root. Roots are treated with thermoplastic for protection, and trimmer protection is available when the column is to be situated on grass. HDPE coatings are available for electrolytical protection in contaminated areas.



Top

We can supply standard post top mountings or an attractive curved hockey-stick style.

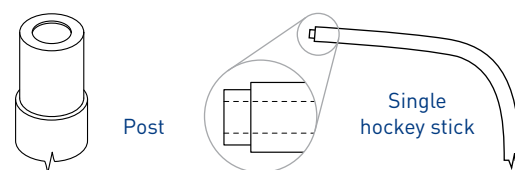

Bracket

We offer a range of brackets to match column and lantern type, all with safety and strength at the heart of their design. An unlimited range of bespoke, architectural bracket designs are also available as a service to customers. Our single and double-arm brackets feature structurally-bonded tube arms mounted on the post top.

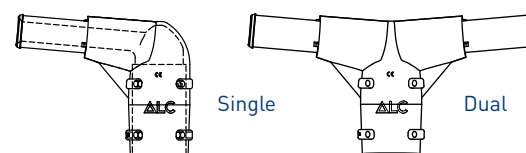

Finish

We always recommend a natural aluminium brushed finish; on customer request we are able to provide a painted/anodized or electrostatic powder coated finish, in a large range of colours.



Stepped and cylindrical

The traditional choice

Conical columns might be a sign of things to come, but we appreciate that many specifiers require columns that can fit in with the aesthetics of existing street lighting schemes.

That's why ALC offers a range of both cylindrical and stepped lighting columns, featuring the same attractive natural aluminium finish as our other products, or with a RAL coating of your choice if you need to match the product to others already in-situ.

These columns are just as passively safe, just as long-lasting and just as environmentally-friendly as all our other columns.

The exact specifications are up to you. You can select from a variety of column heights, base types, lantern mountings and brackets.



“A traditional choice, our stepped and cylindrical columns are just as passively safe as our more modern alternatives.”





“Safe and convenient, our hinged columns offer a long-term maintenance option that saves clients money.”



Hinged columns

One-person maintenance



Our hinged ‘Echalon’ column is a truly revolutionary product. We have often received stakeholder feedback with regards lantern maintenance and lantern replacement: frequently a time consuming and expensive task.

In response to this feedback, we have created a hinged column which uses internal counter-balances to ensure it can be lowered and lifted by a single person. In fact, it can be operated with a single finger!

This operation method means lanterns can be replaced without a cherry picker, and requires no additional equipment – unlike competing products – other than the necessary key.

The hinge can be applied to our conical, stepped or cylindrical columns, from 4m-6m.

Bespoke columns and brackets

The unique solution

ALC has established a leading position in the public lighting industry for the design and supply of specialised bracket forms. Working with the customer from initial brief right through to manufacture and delivery we employ the full resources of our in-house design team to ensure that every aspect of the design brief is satisfied. Our design technology and software includes "Finite Element Analysis" enabling us to complete a design on screen with the certainty of structural integrity.

Bespoke bracketry is often used to support an overall design motif for an area and complex structures are commonly called for. The material properties of aluminium facilitate ambitious and complex designs, while our engineering systems ensure that the full requirements of all relevant product standards are also satisfied.

At ALC we use Finite Element Analysis to aid our product development time, enabling bespoke solutions to be delivered sooner. The process allows simulated loading to identify stress points and design modifications so that final design and structural calculations are completed much earlier.



"We've had great success at taking our customers' ideas on board and creating something really special."





**Wrexham
column**



**Crescent
bracket**

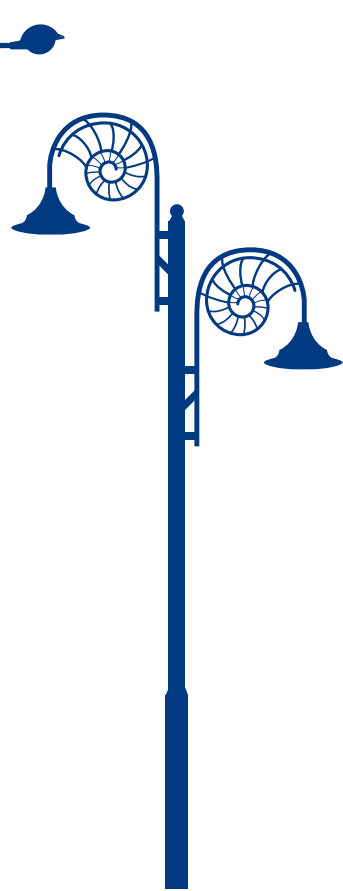

**Ammonite
bracket**



**Heritage
column**

'Off the shelf' delivery

We can quote for, design, manufacture and deliver bespoke columns at speeds close to those for standard columns.





**Call our customer service team on
01639 852502**

**For more information please visit
www.aluminium-lighting.com**

Aluminium Lighting Company Limited

Croeserw Industrial Estate, Eastern Avenue
Cymmer, Port Talbot SA13 3PB

T: 01639 852502

F: 01639 852263

E: sales@alulight.co.uk

W: www.aluminium-lighting.com

Distribution partners:



MARWOOD
LIGHTING
DISTRIBUTORS



Best Value

ALC offers the best return on investment in the market, with tangible and significant long-term cost savings.

Robust

Our industry-leading manufacturing process guarantees strength built-in, and aluminium won't corrode so structural integrity is maintained long-term.

Long Life

An aluminium column from ALC has a design life of 50 years (with a track record in the ground exceeding this) – far outlasting steel or concrete.

Low Maintenance

No need to paint and no need to survey for structural integrity; we even offer a hinged column for easy lantern access.

Passively Safe

Aluminium absorbs kinetic energy better than competing materials, so our columns are less likely to kill or cause harm during a road traffic accident.

Sustainable

Our aluminium is 100% recycled and 100% recyclable, and has a lower carbon footprint than alternative column materials.

Easy Selection

The ALC website features an interactive product selector for quick enquiries, and once we're aware of your requirements we can agree long-term specifications to make your purchasing even easier in the future. Please visit: www.aluminium-lighting.com



Printed upon 100% recycled paper using environmentally friendly processes
Designed and produced by Horizon Digital Media Ltd www.horizondml.co.uk